

H5111



Modulo garage Wi-Fi GoSmart



Indice dei contenuti

Istruzioni e avvertenze di sicurezza.....	2
Contenuto della confezione	3
Specifiche tecniche.....	3
Descrizione del dispositivo	4
Installazione e montaggio	5
Controlli e funzioni.....	11
Modelli compatibili	13
FAQ sulla risoluzione dei problemi.....	28

Istruzioni e avvertenze di sicurezza



Prima di utilizzare il dispositivo, leggere le istruzioni per l'uso.



Osservare le istruzioni di sicurezza contenute in questo manuale.

EMOS spol. s r.o. dichiara che i prodotti H5111 sono conformi ai requisiti essenziali e alle altre disposizioni pertinenti delle direttive. L'apparecchiatura può essere utilizzata liberamente nell'UE.

La dichiarazione di conformità è disponibile sul sito web <http://www.emos.eu/download>.

L'apparecchiatura può essere utilizzata sulla base dell'autorizzazione generale n. VO-R/10/07.2021-8 e successive modifiche.

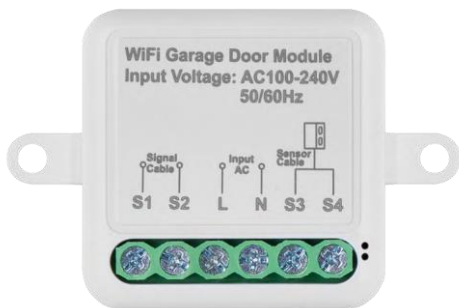

**Contenuto
della
confezione**
Modulo di
commutazione
Manuale Sensore
magnetico

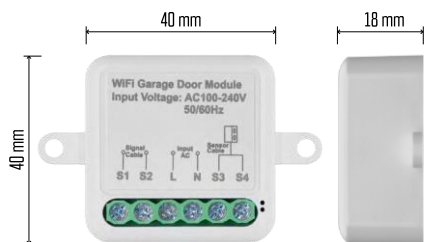

Specifiche tecniche

Alimentazione: AC 100-240 V 50/60 Hz

Dimensioni: 40 × 40 × 18 mm

Peso netto: 30 g

App:EMOS GoSmart per Android e iOS Protocollo di
comunicazione:Wi-Fi IEEE 802.11b/g/n
2,412GHz-2,484GHz

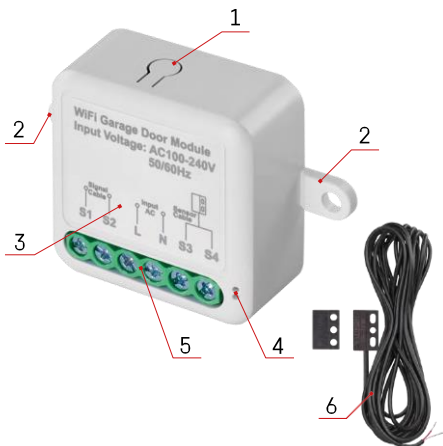

Descrizione del dispositivo

- 1 - Pulsante RESET
- 2 - Fori per il montaggio
- 3 - Schema di cablaggio del modulo interessato
- 4 - LED di stato
 - Blu lampeggiante - Il dispositivo è in modalità di accoppiamento / si è disconnesso dalla rete
 - Illuminato in blu - Il dispositivo è in modalità operativa
- 5 - Morsettiera per il collegamento del cablaggio
- 6 - Sensore magnetico

Avviso

Si raccomanda vivamente che l'installazione del modulo Smart Garage sia effettuata da una persona esperta di cablaggio elettrico. Un'installazione mal eseguita può comportare il rischio di scosse elettriche. Seguire attentamente le seguenti istruzioni e rispettare i carichi massimi dell'apparecchiatura elencati di seguito per garantire un funzionamento sicuro e corretto.

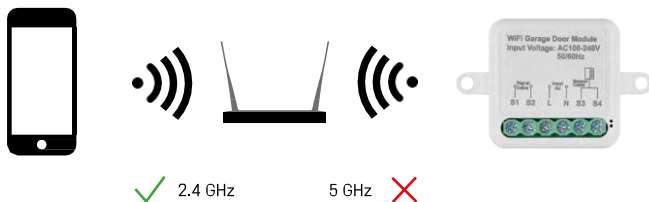

Il modulo supporta solo il Wi-Fi a 2,4 GHz (non supporta il 5 GHz).

Installazione e montaggio

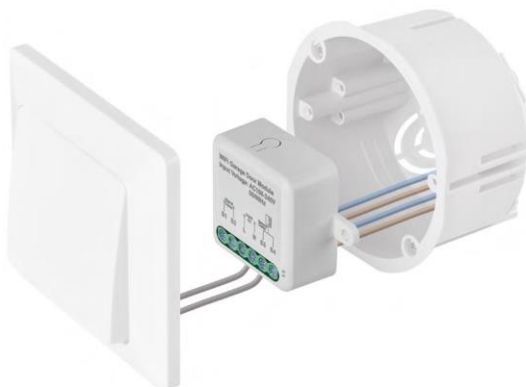

Posizionare il modulo collegato nella scatola di installazione sotto l'interruttore. Grazie alla possibilità di fissaggio, il modulo può essere installato anche in altri luoghi (ad esempio sotto il cartongesso, nel soffitto...) Lo schema di cablaggio è riportato di seguito.

Dal punto di vista funzionale e della sicurezza, è essenziale che tutti i cavi collegati a questo modulo siano spellati all'estremità con una lunghezza di 7 mm.



Schema elettrico

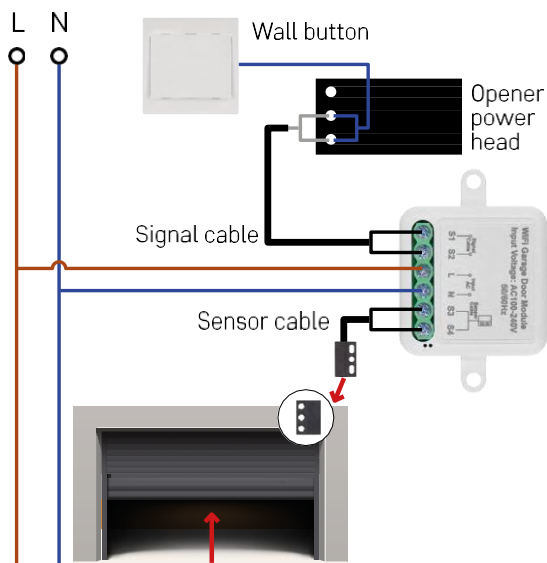

Il collegamento dipende dalle possibilità del garage e dell'apriporta. Il primo passo è verificare la compatibilità del modulo per garage con l'apriporta. Se è già stato installato un apriporta fisico, il modulo sarà compatibile. Se non avete un pulsante, dovete trovare le porte di ingresso per il pulsante nel manuale dell'apriporta e collegarvi il modulo.

Verifica della compatibilità

Verificate che il vostro apri garage sia elencato nella tabella "Modelli compatibili" alla fine di questo documento. In caso contrario, seguire la procedura descritta di seguito:

1. È improbabile che gli apriporta di garage con un pulsante "Learn" giallo o viola funzionino. Gli apriporta con questa caratteristica sono solitamente limitati all'apertura con i telecomandi, non con un pulsante esterno.



2. Nelle istruzioni/schema del meccanismo di apertura del garage, trovare i terminali a cui collegare l'interruttore classico e provare a cortocircuitare il segnale tra questi due terminali. Se questo provoca l'apertura della porta del garage, il modulo è compatibile con questo apriporta.



Installazione del modulo

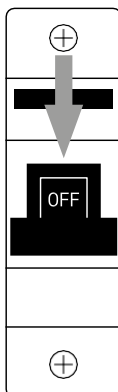

1. Spegnete il modulo e il meccanismo di apertura del garage.
2. Collegare i fili LN ai pin corrispondenti (L,N)
3. Collegare i fili tra il meccanismo di apertura del garage e il terminale del modulo.

Installazione del sensore magnetico

Il cavo del sensore magnetico è lungo 5 metri, quindi il sensore deve essere installato entro questo raggio. Il sensore funziona secondo un principio semplice: rileva se le due metà del magnete sono in contatto. Ciò consente al modulo di rilevare se la porta del garage è aperta o chiusa. La posizione del sensore dipende quindi dalla disposizione specifica e dallo spazio disponibile nel garage. Il magnete può essere montato su diverse superfici, come pareti, staffe della porta o elementi strutturali.

Collegare il cavo del sensore ai terminali appropriati del modulo (S3, S4).

Accoppiamento con un'applicazione

Installazione dell'applicazione EMOS GoSmart



- L'applicazione è disponibile per Android e iOS tramite Google Play e App Store.
- Scansionare il codice QR per scaricare l'applicazione.

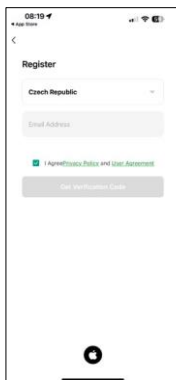
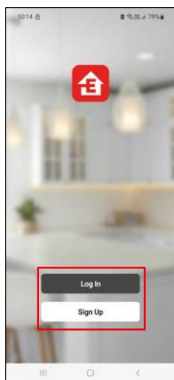
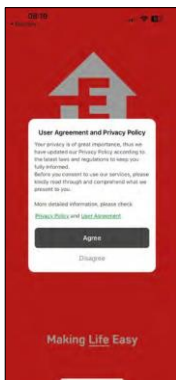

Aprire l'applicazione EMOS GoSmart e confermare l'informativa sulla privacy e fare clic su Accetto. Selezionare l'opzione di registrazione.

Inserire il nome di un indirizzo e-mail valido e scegliere una password. Confermare il consenso all'informativa sulla privacy. Selezionare la registrazione.

Accoppiamento con un'app

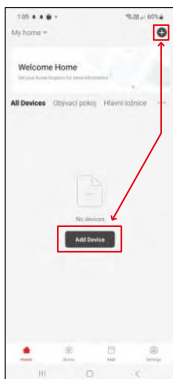

Selezionare Aggiungi dispositivo.

Selezionare la categoria di prodotti GoSmart e il modulo Smart Garage.

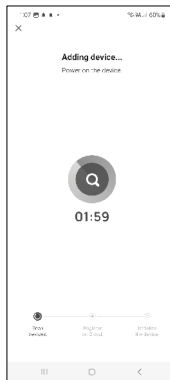

Resettare il modulo tenendo premuto il pulsante RESET per 5 secondi e verificare che il LED lampeggi. Verrà eseguita una ricerca automatica del dispositivo. Dopo l'accoppiamento, l'applicazione visualizza una schermata di conferma. Utilizzare l'icona della matita per assegnare un nome al modulo in base alle proprie esigenze.

Controlli e funzioni

Icone e spie luminose

- 1 - Impostazioni dell'estensione
(descritto in modo più dettagliato nel capitolo successivo)
- 2 - Visualizzazione dello stato corrente
(Aperto/Chiuso)
- 3 - Pulsante di controllo
- 4 - Record
- 5 - Pianificazione
- 6 - Timer
- 7 - Impostazioni
(Impostazione della password per l'assistente Google e tempo di percorrenza della porta)

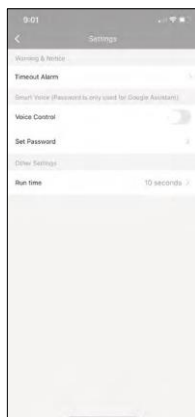
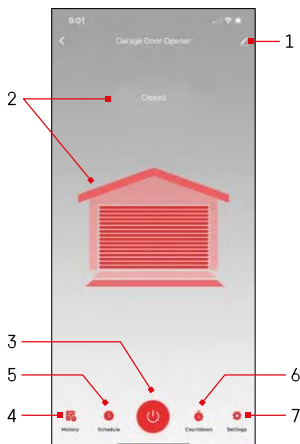

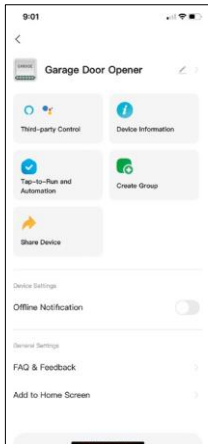

Descrizione delle impostazioni dell'estensione

- Controllo di terze parti - Impostazioni di Alexa e Google Assistant
- Informazioni sul dispositivo: informazioni di base sul dispositivo e sul suo proprietario.
- Tap-to-Run e Automazione - Visualizza le scene e le automazioni assegnate al dispositivo. La creazione di scene è possibile direttamente nel menu principale dell'applicazione, nella sezione "Scene".
- Crea gruppo - Crea gruppi di dispositivi
- Condividi dispositivo: consente di condividere la gestione del dispositivo con un altro utente
- Notifica offline - Per evitare continui promemoria, viene inviata una notifica se il dispositivo rimane offline per più di 30 minuti.
- FAQ e Feedback - Visualizza le domande più comuni con le relative soluzioni e la possibilità di inviare una domanda/suggerimento/feedback direttamente a noi.
- Aggiungi alla schermata iniziale - Aggiunge un'icona alla schermata iniziale del telefono. Con questo passaggio, non è necessario aprire ogni volta il dispositivo attraverso l'app, ma è sufficiente fare clic direttamente sull'icona aggiunta per accedere direttamente al modulo.

Modelli compatibili

Manufacturer	Model
4Ddoors	GA103
AERF	DUAL 2H4 MN
AERF	POWER 1R0
AHOUSE	EM SWING GATE
AHOUSE	RAM 100
Aiphone	JO-1FD
ALEKO	13XX
ALEKO	22XX
ALEKO	AC1400
ALEKO	AR1400
ALEKO	AR900
ALEKO	AS 1300
ALEKO	AS 450
ALEKO	AS 650
ALEKO	AS 900
ALEKO	GateGuard 1300
ALEKO	GateGuard 1700
ALEKO	GateGuard 450
ALEKO	GateGuard 650
ALEKO	GateGuard 850
ALEKO	GateGuard 900
ALL-O-MATIC	SL-100
ALL-O-MATIC	SL-100DC
ALL-O-MATIC	SL-150
ALL-O-MATIC	SL-150DC
ALL-O-MATIC	SL-150DC-50
ALL-O-MATIC	SL-45DC
ALL-O-MATIC	SL-90DC
ALL-O-MATIC	SW-300
ALL-O-MATIC	SW-350
ALL-O-MATIC	TORO 24
ALLMATIC	AV
ALLMATIC	AV1
ALLSTAR	3000
ALLSTAR	3500
ALLSTAR	3500-P
ALLSTAR	6000
ALLSTAR	6500
ALLSTAR	6500-P
ALLSTAR	AC9000 Series
ALLSTAR	(IA(Type II))
ALLSTAR	J3500
ALLSTAR	J6500
ALLSTAR	GS4000
ALLSTAR	MVP
Alulux	Benny 3.0

Manufacturer	Model
Alutech	Levigato (LG Series)
Ansa	RS-1
Ansa	Thermaglidle
APC	CB-SGX12
APC	CBSW-24
APERTO	550L
APERTO	868L
APERTO	868 LX
APERTO	Baseline+
Apollo	1050
Apollo	1500
Apollo	1550ETL
Apollo	1650
Apollo	1650ETL
Apollo	3500ETL
Apollo	3600ETL
Apollo	633 Control Board
Apollo	634 Control Board
Apollo	635
Apollo	636
Apollo	7000ETL
Apollo	835
Apollo	836
Aprimatic	ALZO 55 with Control board T230
Aprimatic	EM51 with control board T3EC-T3SC
ASA	asa300
ASA	asa400
ASA	K50 Control Board
Assa Abloy	840C-50
Assa Abloy	841C-35
Assa Abloy	841C-50
Assa Abloy	850C-50
Assa Abloy	851C-35
Assa Abloy	851C-50
Auto-Over	DC850
Automat Easy	SCOR 800
Automatic Remote	PY500AC
Automatic Technology	DCB-05
Automatic Technology	DCB-05V2
Automatic Technology	GDO-11v1 Ero
Automatic Technology	GDO-11v3
Automatic Technology	GDO-2
Automatic Technology	GDO-2v6
Automatic Technology	GDO-2v7

Manufacturer	Model
Automatic Technology	GDO-4
Automatic Technology	GDO-6
Automatic Technology	GDO-6v2
Automatic Technology	GDO-6v3
Automatic Technology	GDO-6v4
Automatic Technology	GDO-7v2
Automatic Technology	GDO-8
Automatic Technology	GDO-8v3
Automatic Technology	GDO-9
Automatic Technology	GDO-9 Dynamo
Automatic Technology	GDO-9v2
Automatic Technology	GDO-9v2 Gen2
Automatic Technology	NES-24v1
Automatic Technology	NES-24v3 NeoSlider
Automatic Technology	Securalift
Automatic Technology	SG01v3
AVANTI	Garage Door
AVANTI	SD0-21
AVANTI	T-Series
AVANTI	T-Series-v3
AVIDSEN	1600
AVIDSEN	350
AVIDSEN	Anthea
AVIDSEN	EVER212
AVIDSEN	Styrka
B&D	CAD4
B&D	CADP-Diamond series (older model)
B&D	Control-A-Door Diamond PD
B&D	Control-A-Door P Diamond
B&D	Control-A-Door S
B&D	Firmamatic
B&D	MPC-2
B&D	ROD-1v2PD
B&D	ROD-1v4
B&D	Roll-A-Pro
B&D	SD0-1v2 P
B&D	SD0-2v2
B&D	SD0-2v2 ADV
B&D	SD0-3V1 CADS
B&D	SD0-3V2 CADS
B&D	SD0-4v1
B&D	Tilt-A-Matic
B&D	TRG-306
Baisheng	PKD2.3K
BENINCA	BRAINY 230
BENINCA	BRAINY 24
BENINCA	BULL10

Manufacturer	Model
BENINCA	BULL 424
BENINCA	BULL 5M
BENINCA	BULL 80M
BENINCA	CP.B1024ESA
BENINCA	CP.B24ESA
BENINCA	CP.BULL-RI Control unit
BENINCA	CP.C0RE
BENINCA	CP.J4 ESA
BENINCA	CP_J3 Control Unit
BENINCA	DA.93AM
BENINCA	DU350
BENINCA	Heady
BENINCA	JM3
BENINCA	JM3 ESA
BENINCA	MS4
BENINCA	THINK Control Unit
BENINCA	JM4
BENINCA	MS4
BERNAL	S 101-60
BERNAL	S 101-80
BERNAL	G402-120
BERNAL	Rallye C
Berner	GA203
Berner	GA70
Berner	GA80
BFT	Alcor N
BFT	Argo
BFT	ARIES
BFT	ARIES P
BFT	Botticelli
BFT	Deimos
BFT	DEIMOS ULTRABT A 600
BFT	DeimosBT
BFT	DEIMOSBT A 400
BFT	DEIMOSBT A 600
BFT	DEIMOS ULTRABT A400
BFT	ECOSOL
BFT	ELBA BU
BFT	ELI250BT
BFT	EOS
BFT	EOS 120
BFT	I GEABT(Thalia P Control Panel)
BFT	KustosUltraBTA
BFT	Icaro(Leo-D-Ma control panel)
SFT	LEO B CBB3 120 F04
SFT	LEO B CBB3 230 L04
SFT	LEO B CBB3 120 F02
BFT	LEO B CBB3 230 L02

Manufacturer	Model
BFT	LIBRA-UL-R
BFT	Phobos BT and NT NL
BFT	Phobos N L BT
BFT	Rigel4
BFT	Rigel5
BFT	Tir 20
BFT	Tir 60
BFT	VIRGO
BFT	ZARA BTL2
Biltek	sl600acl
BOSH	Profilift
BOSS	bol5
BOSS	bol6
BOSS	B0L4
BOSS	FORZA
BYAN	G2M Control Board
BYOU	BEAUTY
CAB	DUMPER 10
CAB	DUMPER 7
CAME	BK1200
CAME	BK1800
CAME	BK2200
CAME	BK800
CAME	BKE1200
CAME	BKE1800
CAME	BKE2200
CAME	BX241
CAME	BX243
CAME	ZA3N
CAME	ZA4
CAME	ZL-J24
CAME	ZM3E
CAME	ZM3EC
CARDALE	DC650N
CARDALE	DC650T
CARDALE	DC685
CARDIN	sl324ebsb
Centurion	Avanti
Centurion	D2 Turbo
Centurion	D5 EVO
Challenger	CH-1000
Chamberlain	1270
Chamberlain	1280
Chamberlain	1280R
Chamberlain	1345M
Chamberlain	1346M
Chamberlain	1355M
Chamberlain	1356M

Manufacturer	Model
Chamberlain	2110
Chamberlain	2200C
Chamberlain	2220
Chamberlain	2220-267
Chamberlain	2265
Chamberlain	2265-267
Chamberlain	248730
Chamberlain	248735S
Chamberlain	248739
Chamberlain	248754
Chamberlain	2500B
Chamberlain	2595
Chamberlain	3245
Chamberlain	3245CM
Chamberlain	3245M
Chamberlain	3255
Chamberlain	3255-2CM
Chamberlain	3255-2
Chamberlain	3255-2M
Chamberlain	3255CM
Chamberlain	3255M
Chamberlain	3265CM
Chamberlain	3265CM-267
Chamberlain	3280
Chamberlain	3280-267
Chamberlain	3575
Chamberlain	3595S
Chamberlain	3850
Chamberlain	3850-267
Chamberlain	4200C-2
Chamberlain	4200C
Chamberlain	7902
Chamberlain	7902K
Chamberlain	9902
Chamberlain	AccessMaster M3100M
Chamberlain	AccessMaster M350M
Chamberlain	AccessMaster M385M
Chamberlain	B500
Chamberlain	B503
Chamberlain	B510
Chamberlain	B550
Chamberlain	B552
Chamberlain	B970
Chamberlain	C203
Chamberlain	C205
Chamberlain	C400
Chamberlain	C410
Chamberlain	CG40

Manufacturer	Model
Chamberlain	CG40CDM
Chamberlain	CG42CDM
Chamberlain	CR600
Chamberlain	CR625EVO
Chamberlain	CR675EVO
Chamberlain	CS100EVO
Chamberlain	CS110MYQ
Chamberlain	CS60EVO
Chamberlain	HC300-433
Chamberlain	HD200D
Chamberlain	HD200DM
Chamberlain	HD400D
Chamberlain	HD600
Chamberlain	HD950WF
Chamberlain	LM60XX
Chamberlain	LM80XX
Chamberlain	LW1000WF
Chamberlain	LW2000
Chamberlain	LW260C
Chamberlain	LW3000
Chamberlain	LW9000WF
Chamberlain	M385
Chamberlain	M385M
Chamberlain	Miracle-ONE
Chamberlain	MJ -MH-HMJ
Chamberlain	ML 1000EV
Chamberlain	ML 510EV
Chamberlain	ML2000
Chamberlain	ML700EV
Chamberlain	Motorlift 5500
Chamberlain	Motorlift 1000
Chamberlain	Motorlift 2000
Chamberlain	Motorlift 4000
Chamberlain	Motorlift 5000
Chamberlain	Motorlift 700
Chamberlain	Motorlift ML500
Chamberlain	Motorlift ML510
Chamberlain	Motorlift ML700
Chamberlain	MotorLift ML750
Chamberlain	MotorLift ML850
Chamberlain	MSLDCBB3
Chamberlain	MSWDCBB
Chamberlain	PD210
Chamberlain	PD212D
Chamberlain	PD300
Chamberlain	PD610D
Chamberlain	PD612D
Chamberlain	PD752KDS

Manufacturer	Model
Chamberlain	PD758DS
Chamberlain	PD758KDS
Chamberlain	Robo Swing R900
Chamberlain	Sentex Crown Jewel
Chamberlain	The Robo slide
Chamberlain	TPD10-05
Chamberlain	WD822KD
Chamberlain	WD832KD
Chamberlain	WD832KEV
Chamberlain	WD832KEVG
Chamberlain	Whisper Drive HD601
Chamberlain	Whisper Drive 24873
Chamberlain	Whisper Drive 24873
Chamberlain	Whisper Drive 24875
Chamberlain	Whisper Drive 45995
Chamberlain	Whisper Drive 54744
Chamberlain	Whisper Drive 940CD
Chamberlain	Whisper Drive HD600
Chamberlain	Whisper Drive HDB00D
Chamberlain	Whisper Drive Plus
Chamberlain	Whisper Drive WD82
Chamberlain	Whisper Drive HD900D
Chamberlain	Whisper Drive WD83
Chamberlain	Whisper Drive 8200
Chamberlain	Whisper Drive 9200
Chamberlain	PowerDrive HD200D
Chamberlain	PowerDrive HD400D
Chamberlain	PowerDrive LW2000
Chamberlain	PowerDrive LW3000
Chamberlain	PowerDrive PD210
Chamberlain	PowerDrive PD212D
Chamberlain	PowerDrive PD610D
Chamberlain	PowerDrive PD612D
Chamberlain	PowerDrive PD752D
Chamberlain	PowerDrive PD752KLD
Comfort	260
Comfort	270
Comfort	280
Commmax	DP-2HP
CRAFTSMAN	13953918D
CRAFTSMAN	139-53985
CRAFTSMAN	139.18076
CRAFTSMAN	139.18086
CRAFTSMAN	139.18096
CRAFTSMAN	139.18458D
CRAFTSMAN	139.18585D
CRAFTSMAN	139.18586D
CRAFTSMAN	139.18675

Manufacturer	Model
CRAFTSMAN	139.18676
CRAFTSMAN	139.18686
CRAFTSMAN	139.18696
CRAFTSMAN	139.18803
CRAFTSMAN	139.18805
CRAFTSMAN	139.18814
CRAFTSMAN	139.18830
CRAFTSMAN	139.18850
CRAFTSMAN	139.18851
CRAFTSMAN	139.18865
CRAFTSMAN	139.18866
CRAFTSMAN	139.18875
CRAFTSMAN	139.18876
CRAFTSMAN	139.18975
CRAFTSMAN	139.53638SRT
CRAFTSMAN	139.53662SRT
CRAFTSMAN	139.53675SRT
CRAFTSMAN	139.53681B
CRAFTSMAN	139.53910
CRAFTSMAN	139.53910D
CRAFTSMAN	139.53914
CRAFTSMAN	139.53919D
CRAFTSMAN	139.53920D
CRAFTSMAN	139.53924
CRAFTSMAN	139.53954
CRAFTSMAN	139.53961
CRAFTSMAN	139.53961SRT
CRAFTSMAN	139.53962SRT1
CRAFTSMAN	139.53964SRT
CRAFTSMAN	139.53974
CRAFTSMAN	139.53990
CRAFTSMAN	139.53990D
CRAFTSMAN	139.53992
CRAFTSMAN	139.53992D
CRAFTSMAN	139.54915
CRAFTSMAN	139.54918
CRAFTSMAN	139.54931
CRAFTSMAN	139.54985
CRAFTSMAN	139.54990
CRAFTSMAN	139.653000
CRAFTSMAN	13918054
CRAFTSMAN	13918056
CRAFTSMAN	13918058
CRAFTSMAN	13918059
CRAFTSMAN	13918060
CRAFTSMAN	13918405D
CRAFTSMAN	13918451D
CRAFTSMAN	13918452D

Manufacturer	Model
CRAFTSMAN	13918458DM
CRAFTSMAN	13918463D
CRAFTSMAN	13918470D
CRAFTSMAN	13918473D
CRAFTSMAN	13918489D
CRAFTSMAN	13918555
CRAFTSMAN	13918654
CRAFTSMAN	13918656
CRAFTSMAN	13918658
CRAFTSMAN	13918659
CRAFTSMAN	13918660
CRAFTSMAN	13918673
CRAFTSMAN	13918674
CRAFTSMAN	13918887
CRAFTSMAN	13918897
CRAFTSMAN	13918973
CRAFTSMAN	13918974
CRAFTSMAN	13953315SR
CRAFTSMAN	13953335SRT3
CRAFTSMAN	13953415SR
CRAFTSMAN	13953627SRT
CRAFTSMAN	13953535SRT1
CRAFTSMAN	1395353834SRT3
CRAFTSMAN	13953615SR
CRAFTSMAN	13953627SRT
CRAFTSMAN	13953628SRT
CRAFTSMAN	13953636SRT
CRAFTSMAN	13953640SRT
CRAFTSMAN	13953641SRT
CRAFTSMAN	13953644SRT
CRAFTSMAN	13953645SRT3
CRAFTSMAN	13953646SRT2
CRAFTSMAN	13953647SRT1
CRAFTSMAN	1395364812
CRAFTSMAN	13953648SRT2
CRAFTSMAN	13953650SRT
CRAFTSMAN	13953660SRT1
CRAFTSMAN	13953661SRT3
CRAFTSMAN	13953662SRT2
CRAFTSMAN	13953670SRT1
CRAFTSMAN	13953671SRT3
CRAFTSMAN	13953672SRT3
CRAFTSMAN	13953673SRT3
CRAFTSMAN	13953674SRT3
CRAFTSMAN	13953675SRT2
CRAFTSMAN	13953677SRT3
CRAFTSMAN	13953699SR
CRAFTSMAN	13953834SRT3

Manufacturer	Model
CRAFTSMAN	139S3901DM
CRAFTSMAN	139S3903DM
CRAFTSMAN	139S3905DM
CRAFTSMAN	139S3915D
CRAFTSMAN	139S3916D
CRAFTSMAN	139S3918D
CRAFTSMAN	139S3918D
CRAFTSMAN	139S3930D
CRAFTSMAN	139S3930DM
CRAFTSMAN	139S3961
CRAFTSMAN	139S3961SRT
CRAFTSMAN	139S3962SRT
CRAFTSMAN	139S3962SRT
CRAFTSMAN	139S3963SRT
CRAFTSMAN	139S3964SRT
CRAFTSMAN	139S3974
CRAFTSMAN	139S3974SRT
CRAFTSMAN	139S3975SRT
CRAFTSMAN	139S3975SRT
CRAFTSMAN	139S3976
CRAFTSMAN	139S3976SRT
CRAFTSMAN	139S3977SRT
CRAFTSMAN	139S3978
CRAFTSMAN	139S3978SRT
CRAFTSMAN	139S3978SRT1
CRAFTSMAN	139S3982SRT
CRAFTSMAN	139S398511
CRAFTSMAN	139S3985DM
CRAFTSMAN	139S3990D
CRAFTSMAN	139S3993D
CRAFTSMAN	139S3995SRT
CRAFTSMAN	139S4930
CRAFTSMAN	20057933
CRAFTSMAN	75th Anniversary Model139.53991
CRAWFORD	Ultra Excellent
CRAWFORD	Ultra S
CRAWFORD	ECS 930A
CRAWFORD	ECS 940A
CRAWFORD	ECS 950
CRAWFORD	Magic 1000
CRAWFORD	Magic 600
CRAWFORD	Ultra
DASPI	MAX
Daidsen	Portautomatik N600-240
DC MOTO	GFM925AL
DEA	203RR-Control Panel-
DEA	212E-Control Panel-

Manufacturer	Model
DIMOEL	Corredera 400
DIMOEL	Kit NewROTOR
Diplomat	CD550
DITEC	CROSS3E
DITEC	CS12E
DITEC	CS12M (for NEOS)
DITEC	D2H
DITEC	E1(for 230V AC Motors)
DITEC	E1A (for 230V AC Motors)
DITEC	E1A(forCROSS)
DITEC	E1A(forDod)
DITEC	E1HBOX
DITEC	E1T(forCROSS30)
DITEC	E1T(forDod)
DITEC	E2(forCUBIC)
DITEC	E2H Control Board
DITEC	EL31R(forQik)
DITEC	E134(forQik)
DITEC	Entrematic E1T (for 400V Motors)
DITEC	Entrematic E2 (for 230V AC Motors)
DITEC	GL0SE
DITEC	ION
DITEC	LCU30H (for 24V DC Motors)
DITEC	LCU30H (for ARC)
DITEC	LCU30H (for Facil)
DITEC	LCU30H (for PWR)
DITEC	LCU40H (for 24V DC Motors)
DITEC	LCU40H (for ARC)
DITEC	LCU40H (for CUBIC)
DITEC	LCU40H (for Dor)
DITEC	LCU40H (for Facil)
DITEC	LCU40H (for PWRJ)
DITEC	LOGIC M (for CROSS)
DITEC	LOGIC M (for CUBIC)
DITEC	LOGICM (for 230V AC Motors)
DITEC	NEOS
DITEC	NEOS+
DITEC	obbi 3bh
DITEC	TOP603H
DITEC	TOP903H
DITEC	VIVAH
DITEC	VIVAHJ
DMIL	EVOLUTION
Dominator	GDO-11v1
Dominator	GDO11v3
DOORHAN	SE-500

Manufacturer	Model
DOORHAN	SE-500PRO
DOORHAN	SE-DIY-500
DoorKing	1150
DoorKing	1503
DoorKing	1504
DoorKing	1802 Access Plus
DoorKing	1808 Access Plus
DoorKing	1810 Access Plus
DoorKing	1812 Access Plus
DoorKing	605
DoorKing	610
DoorKing	6524
DoorKing	9024
DoorKing	9100
DoorKing	9150
DoorKing	9200 (Series)
DoorKing	CONTROL BOX:6001-6003-6400
DoorKing	DK4502
DoorKing	DKS9150
DoorKing	DKS6500
DoorKing	DKS 6050
DoorKing	DKS 6100
DoorKing	DKS 9050
DoorKing	DKS9310
Doorworks	1200N
Doorworks	800N
Doorworks	RD2
DORENE	DR 3020
DORENE	DR 3020HX
DORENE	DRT 3520
DorGo	800
DOWNEE	NET230N
DTS	DTS 600
DTS	DTS 800
Ducati	EVO 700FC
Ducati	EVO 700T
Ducati	HC619 Solar
Ducati	HC812-300
Ducati	EVO 700
E.T. SYSTEMS	DC BLUE ADVANCED
E.T. SYSTEMS	DC Blue Digital
E8	E8-300
EAGLE	100 Series
EAGLE	1000
EAGLE	200 Series
EAGLE	2000
EAGLE	E7
EAGLE	Eagle-1

Manufacturer	Model
Eco Garage Doors	FS 1000
EL SEMA	Eclipse MC
ELBE	909A
ELBE	909B
ELITE	CSW-200 Series
ELITE	Miracle 1-MS
ELITE	Roboslide
ELITE	SL-3000-UI
ELLARD	Athena
EntranceDynamics	EDSL4S0
Entrematic	230V AC Motors (E1)
Entrematic	Dod (E1A)
Entrematic	NE0S+ (CS12E)
Entrematic	30v AC Motors (E1A)
Entrematic	230V AC Motors (Entrematic E2)
Entrematic	230V AC Motors (LOGICM)
Entrematic	230V AC Motors (LOGICM)
Entrematic	24V DC Motors (LCU30H)
Entrematic	24V DC Motors (ICU40H)
Entrematic	400V Motors (Entrematic EIT)
Entrematic	Akku Plus
Entrematic	ARC (LCU30H)
Entrematic	ARC (ICU40H)
Entrematic	CROSS(E1A)
Entrematic	CROSS {LOGICM}
Entrematic	CROSS 30 (E1T)
Entrematic	CROSS 3E
Entrematic	CUBJC (E2)
Entrematic	CUBIC (LCU40H)
Entrematic	CUBIC (LOGICM)
Entrematic	D2H
Entrematic	Dod(E1T)
Entrematic	Dor (LCU40H)
Entrematic	E1HBOX
Entrematic	E2H Control Board
Entrematic	Elegance 2500 (Control X50)
Entrematic	Elegance 2500 (Control X51)
Entrematic	Elegance 4000 (Control X50)
Entrematic	Elegance 4000 (Control X51)
Entrematic	Elegant 200
Entrematic	Elegant 400 (Control VD003)
Entrematic	EVO400
Entrematic	EVO 600
Entrematic	EVO 800
Entrematic	Facil (LCU30H)
Entrematic	Facil (LCU40H)
Entrematic	GLOBE
Entrematic	ION

Manufacturer	Model
Entrematic	LEVO 3000
Entrematic	LEVO4000
Entrematic	MAGIC 1000
Entrematic	MAGIC 600
Entrematic	Mono
Entrematic	NEOS (CS12E)
Entrematic	NEOS (CS12M)
Entrematic	NEOS+ (CS12M)
Entrematic	Noblese 400 (Control X80)
Entrematic	Noblese 400 (Control X81)
Entrematic	Noblese 800 (Control X80)
Entrematic	Noblese 800 (Control X81)
Entrematic	obbi 3bh
Entrematic	Perfekt
Entrematic	PWR (LCU30H)
Entrematic	PWR (LCU40H)
Entrematic	Qik(EL31R)
Entrematic	Qik(EL34)
Entrematic	TOP603H
Entrematic	TOP903H
Entrematic	ULTRA
Entrematic	ULTRA Excellent
Entrematic	Ultra S
Entrematic	Universal 400
Entrematic	VIVAH
Entrematic	VIVAHJ
Entrematic	WS 1000 (control VD003)
Entrematic	WS 350 (control VD003)
Entrematic	WS 600 (control VD003)
ERREKA	KM400
ESTATE SWING	E-S1100
ESTATE SWING	E-S 1102
ESTATE SWING	E-S 1600
ESTATE SWING	E-S 1602
ETDOOR	ET-1000E
ETDOOR	ET-600E
ETDOOR	ET-800E
EUROMATIC	LEVER 400
EUROMATIC	Control Board IDEA 8-R
EVOLOGY	EVOSLIDE 5000
FAAC	400
FAAC	401MP
FAAC	414P
FAAC	450MPS
FAAC	455D
FAAC	624BLD
FAAC	740
FAAC	741

Manufacturer	Model
FAAC	C720
FAAC	E024S
FAAC	E600
FAAC	S800H (E024U Control Unit)
FADINI	COMBI 740
FAS	SLIDECH300BBUP
Force	fs1000
FOREMATIC	F350
FOREMATIC	F360
FORESSE	F-350G
FORESSE	F-350M
FORZA	1000
Garador	GaraMatic 10
Garador	GaraMatic 20
GARAGA	CarGO 500e
GARAGA	CarGO 700e
GARDALE	DC-650n
GAREN	Centrat G3
GATEKEEPER	YG-5602
GDS	450 LI
GDS	630 LI Range
GDS	800
GELB	ECU-1M03
Generic 3 Button Commercial Door	3 Button Commercial Door
GENESIS	3055
GENESIS	725
GENESIS	750
GENESIS	777
GENIE	PowerMax (all models)
GENIE	Exceleator(all models)
GENIE	ChainMax (all models)
GENIE	StealthDrive (all models)
GENIE	QuietLift (all models)
GENIE	StealthLift (all models)
GENIE	Chain Drive (all models)
GENIE	Powerlift (all models)
GENIE	Ataddin
GENIE	BELT DRIVE
GENIE	CB1000
GENIE	CB1200
GENIE	Chain Drive 800
GENIE	Chainmax 1000
GENIE	CM7500
GENIE	CM8500
GENIE	CM8600
GENIE	EXCELERATOR
GENIE	GCG Series

Manufacturer	Model
GENIE	GPower 900
GENIE	GPS-IC Series
GENIE	H series
GENIE	IntelliG 1000
GENIE	IntelliG 1200
GENIE	IS850
GENIE	ISD 1000
GENIE	MODEL 1022
GENIE	MODEL 1024
GENIE	MODEL 1028
GENIE	MODEL 1035
GENIE	MODEL 1042
GENIE	MODEL 2020L
GENIE	MODEL 2022
GENIE	MODEL 2024
GENIE	MODEL 2028
GENIE	MODEL 2033
GENIE	MODEL 2035
GENIE	MODEL 2036
GENIE	MODEL 2040C
GENIE	MODEL 2040L
GENIE	MODEL 2042
GENIE	MODEL 2053
GENIE	MODEL 2055
GENIE	MODEL 2060
GENIE	MODEL 2560
GENIE	MODEL 2562
GENIE	MODEL 2568
GENIE	MODEL 3033
GENIE	MODEL 3035
GENIE	MODEL 3053
GENIE	MODEL 3053
GENIE	MODEL 3055
GENIE	MODEL 3060
GENIE	MODEL 3062
GENIE	MODEL 3064
GENIE	MODEL 4062
GENIE	MODEL 4064
GENIE	MODEL 5042
GENIE	MODEL 7033
GENIE	MODEL 7035
GENIE	MODEL 7053
GENIE	MODEL 7055
GENIE	MODEL CB1200
GENIE	MODEL SC1200
GENIE	MODEL2040L
GENIE	MODEL2053
GENIE	MODEL2562

Manufacturer	Model
GENIE	MODEL3024
GENIE	PCG Series
GENIE	PMX-IC B Series
GENIE	PowerLift 900
GENIE	PowerMax1200
GENIE	PowerMax1500
GENIE	PRO MAX
GENIE	PRO STEALTH
GENIE	ReliaG 650
GENIE	ReliaG 850
GENIE	SC1200
GENIE	SC1500
GENIE	ScrewDrive
GENIE	SD8000
GENIE	SD9000
GENIE	SD9500
GENIE	Series H
GENIE	Series IC
GENIE	Series IS
GENIE	Series ISL
GENIE	SilentMax 750
GENIE	TriloG 1200
GENIE	TriloG 1500
GENIUS	Brain 03
GENIUS	Brain 04
GENIUS	Brain 17
GENIUS	Brain 592
GFA	TS 971
GHOST CONTROLS	DEP2 kit
GHOST CONTROLS	DTP1
GHOST CONTROLS	TDS2
GHOST CONTROLS	TSS1XP
GIBiDi	PASS 600 REGO
GLIDEROL	Glidermatic GTS+
Grand-O-Matic	GM1000
Grand-O-Matic	GM1200
Grand-O-Matic	GM800
Grifco	eDrive +2.0
GSM	i-Gate 20
GTO	1500
GTO	25 code Digital Keypad
GTO	GP-SW050
GTO	GTO 3000XLS
GTO	GTO PRO SW-2000XLS
GTO	PRO1000
GTO	SL-1000
GTO	SL-2000
GTO	SW4000XLS

Manufacturer	Model
Guardian	21230L
Guardian	415
Guardian	600SL
Guardian	615
Guardian	628
HBopeners	Easyswing
Heras	HGD230
Heras	HMD230
Heras	IGD230
Herculift	SD0 V8
Hormann	EcoMatic
Hormann	Ecostar B
Hormann	EcostarC
Hormann	GT090
Hormann	LIFTRONIC 500
Hormann	LIFTRONIC 700
Hormann	LIFTRONIC 800
Hormann	LineaMatic
Hormann	Promatic
Hormann	Promatic2
Hormann	Promatic3
Hormann	Rollmatic
Hormann	Rollmatic (Double Swing)
Hormann	Rollmatic (One Door)
Hormann	SilentDrive
Hormann	Supramatic
Hormann	Supramatic 3
Hormann	Supramatic E
Hormann	Supramatic E P
Hormann	Supramatic E2
Hormann	Supramatic H
Hormann	Turbo75
HySecurity	SlideSmart DC 10F
HySecurity	SlideSmart DC 15
HySecurity	SlideSmart DCS 10F
HySecurity	SlideSmart DCS 15
JANUS INTERNATIONAL	Mini Pantheon
Jaytech	CK1200
Jaytech	CK1500
JCM	Keeroll
JCM	MAIN-1EU
JCM	MAIN-2EU
KENNER	KNS 1500
KEY AUTOMATION	14A
KEY AUTOMATION	Star 300
KEY AUTOMATION	Star 500
KIBY	1000
KIBY	600

Manufacturer	Model
KINGGATES	STAR68 24
Liftaway	LA-SD01
LiftMaster	100
LiftMaster	1000SDR
LiftMaster	1040
LiftMaster	1040-6
LiftMaster	1040-9
LiftMaster	1040SM
LiftMaster	1045
LiftMaster	1045-6
LiftMaster	1045-9
LiftMaster	1045JG
LiftMaster	1046-6
LiftMaster	1046-9
LiftMaster	1050
LiftMaster	1050-6
LiftMaster	1050-9
LiftMaster	1050SM
LiftMaster	1055
LiftMaster	1055-253
LiftMaster	1055-6
LiftMaster	1055-9
LiftMaster	1056
LiftMaster	1056-6
LiftMaster	1056-9
LiftMaster	1060
LiftMaster	1060-253
LiftMaster	1060-6
LiftMaster	1060-9
LiftMaster	1060JG
LiftMaster	1140
LiftMaster	1145
LiftMaster	1146
LiftMaster	1150
LiftMaster	1155
LiftMaster	1156
LiftMaster	1160
LiftMaster	1210EM FS2
LiftMaster	1215EM FS2
LiftMaster	1220EM FS2
LiftMaster	1225EM FS2
LiftMaster	1240
LiftMaster	1245-266
LiftMaster	1246
LiftMaster	1250
LiftMaster	1250-266
LiftMaster	1255
LiftMaster	1255166

Manufacturer	Model
LiftMaster	1255266
LiftMaster	1256
LiftMaster	1260
LiftMaster	1260-166
LiftMaster	1260-266
LiftMaster	1260-298
LiftMaster	1265
LiftMaster	1265-267
LiftMaster	1265LMC
LiftMaster	1280LMC-R
LiftMaster	1280R
LiftMaster	1345
LiftMaster	1345M
LiftMaster	1346
LiftMaster	1346M
LiftMaster	1355
LiftMaster	1355M
LiftMaster	1356
LiftMaster	1356M
LiftMaster	200
LiftMaster	2000SDR
LiftMaster	215WD
LiftMaster	2110
LiftMaster	2220
LiftMaster	2220-267
LiftMaster	2245
LiftMaster	2245C
LiftMaster	2255
LiftMaster	2255-2
LiftMaster	2255-2C
LiftMaster	2255C
LiftMaster	2265
LiftMaster	2265-267
LiftMaster	2280
LiftMaster	248730
LiftMaster	2500
LiftMaster	2575
LiftMaster	2585
LiftMaster	300
LiftMaster	3110
LiftMaster	3130M
LiftMaster	312HM
LiftMaster	312HMC
LiftMaster	315WD
LiftMaster	3220
LiftMaster	3220-267
LiftMaster	3240
LiftMaster	3240M

Manufacturer	Model
LiftMaster	3245
LiftMaster	3245M
LiftMaster	3255
LiftMaster	3255-2M
LiftMaster	3255M
LiftMaster	3265
LiftMaster	3265-267
LiftMaster	3270
LiftMaster	3575
LiftMaster	3575CS
LiftMaster	3585
LiftMaster	3585-100
LiftMaster	3585CS
LiftMaster	3585S
LiftMaster	3595S
LiftMaster	3780
LiftMaster	3800
LiftMaster	3800P
LiftMaster	3850
LiftMaster	3850-267
LiftMaster	3950
LiftMaster	412HM
LiftMaster	412HMC
LiftMaster	535-315LMSecurity+Receiver
LiftMaster	5580
LiftMaster	6000MONARCH
LiftMaster	8000MONARCH
LiftMaster	BMT5011
LiftMaster	BMT5011U
LiftMaster	CB1
LiftMaster	CB11
LiftMaster	CB124EV
LiftMaster	CB24
LiftMaster	CSL.24U
LiftMaster	CSL24V
LiftMaster	CSW200
LiftMaster	CSW200101U
LiftMaster	CSW200501U
LiftMaster	CSW200UL
LiftMaster	CSW24U
LiftMaster	ECO300K
LiftMaster	ECO300KS
LiftMaster	ECO400K
LiftMaster	ECO400KS
LiftMaster	Elite MIRACLE 1 (199
LiftMaster	Gate Model 844
LiftMaster	HBW0777
LiftMaster	HCT501130

Manufacturer	Model
LiftMaster	HMJ
LiftMaster	HS670
LiftMaster	J5011L 4
LiftMaster	LA100
LiftMaster	LA350
LiftMaster	LA400DC
LiftMaster	LA400DCS
LiftMaster	LA400LA400S
LiftMaster	LA400PKGUG
LiftMaster	LA412
LiftMaster	LA412-S
LiftMaster	LA412DC
LiftMaster	LA500
LiftMaster	LA500-LA500S
LiftMaster	LA5001PKGDC
LiftMaster	LA500DC
LiftMaster	LA500DCS
LiftMaster	LM100
LiftMaster	LM1000A
LiftMaster	LM50
LiftMaster	LM50
LiftMaster	LM50k
LiftMaster	LM60
LiftMaster	LM600A
LiftMaster	LM60A
LiftMaster	LM60R-128
LiftMaster	LM60XX
LiftMaster	LM60K
LiftMaster	LM70EVK
LiftMaster	LM80
LiftMaster	LM800A
LiftMaster	LM80AR-128
LiftMaster	LM80EVS
LiftMaster	LM80XX
LiftMaster	LM850EV
LiftMaster	LM950EV
LiftMaster	M3100M
LiftMaster	M385M
LiftMaster	MGJ5011U
LiftMaster	MH
LiftMaster	MH5011U
LiftMaster	MHS5011U
LiftMaster	MiracleONE
LiftMaster	MJ
LiftMaster	MJ5011U
LiftMaster	Model APT
LiftMaster	Model GH
LiftMaster	Model GT

Manufacturer	Model
LiftMaster	Model H
LiftMaster	Model HJ
LiftMaster	Model J
LiftMaster	Model Series 1200
LiftMaster	Model Series 1300
LiftMaster	Model T
LiftMaster	Model T (Logic Control ver2)
LiftMaster	MT5011
LiftMaster	MT5011U
LiftMaster	Professional Model Series 1200
LiftMaster	RSL12U
LiftMaster	RSL12V
LiftMaster	RSL12VH
LiftMaster	RSW12VDC
LiftMaster	SL1000
LiftMaster	SL3000501U
LiftMaster	SL3000UL
LiftMaster	SL3000UL8
LiftMaster	SL505
LiftMaster	SL540
LiftMaster	SL570
LiftMaster	SL575
LiftMaster	SL580
LiftMaster	SL585
LiftMaster	SL590
LiftMaster	SL595
LiftMaster	SL600
LiftMaster	SL930
LiftMaster	SW420
LiftMaster	SW470
LiftMaster	SW490
LiftMaster	SWG0370
Linear	2000XLS
Linear	2002XLS
Linear	4000XLS
Linear	6000
Linear	6500
Linear	6500-P
Linear	Allister
Linear	AK-11
Linear	AP-4
Linear	AP-5
Linear	Delta-3
Linear	HSLG
Linear	J6500
Linear	LC075
Linear	LCDCO800
Linear	LD033

Manufacturer	Model
Linear	LD050
Linear	LS0050
Linear	Multi-Code (3-wire)
Linear	Multi-Code 1099-50
Linear	PDS 800
Linear	SLC
Linear	SLD
Linear	SLR
Linear	SWC
Linear	SWD
Linear	SWR
Linear	VS-6SLG
Lynx	455 Plus
Manaras	Opera-MH
Manaras	Opera-MJ
Marantec	CS300
Marantec	211
Marantec	220
Marantec	250
Marantec	252
Marantec	360
Marantec	370
Marantec	Comfort 130
Marantec	Comfort 150
Marantec	Comfort 160
Marantec	Comfort 220.2
Marantec	Comfort 250
Marantec	Comfort 250.2
Marantec	Comfort 250.2 speed
Marantec	Comfort 252
Marantec	Comfort 252.2
Marantec	Comfort 260
Marantec	Comfort 270
Marantec	Comfort 280
Marantec	Comfort 360
Marantec	Comfort 370
Marantec	Comfort 380
Marantec	Comfort 500S
Marantec	Comfort 60
Marantec	Comfort 880
Marantec	Comfort 881
Marantec	Delexe DL2005
Marantec	GDO 500(S or L)
Marantec	GDO 700 (S or L)
Marantec	M4500
Marantec	M4500e
Marantec	M4700
Marantec	M4700e

Manufacturer	Model
Marantec	M4900e
Marantec	M55
Marantec	Q-7500
Marantec	Q-7700
Marantec	Synergy 260
Marantec	Synergy 270
Marantec	Synergy 280
Marantec	Synergy 360
Marantec	Synergy 370
Marantec	Synergy 380
MARTIN	DC2500
MARTIN	DC2500e
MARTIN	DC3700
MARTIN	DC3700e
MAX - Maximum Controls-	MAX F18
MERIK	200M
MERIK	230 Plus
MERIK	411M
MERIK	711M
MERIK	Merik 230 Plus
MERIK	PC160 (Control Box)
MERIK	PC170 (Control box)
MERLIN	G715D
MERLIN	M230T
MERLIN	MR650EVO
MERLIN	MR850EVO
MERLIN	MT1000EVO
MERLIN	MT5580P
MERLIN	MT60
MERLIN	MT60P
MFZ	CS 300
Mhouse	SL1 and SL10
Mhouse	WG20
Micanan	Pro LJ
Mighty Mule	200
Mighty Mule	350
Mighty Mule	362D
Mighty Mule	500
Mighty Mule	502
Mighty Mule	FM145
Mighty Mule	FM402
Mighty Mule	MM600
Moore-o-Matic	700
Moore-o-Matic	700-240
Moore-o-Matic	727
Moore-o-Matic	750
Moore-o-Matic	757

Manufacturer	Model
Moore-o-Matic	X125
Moore-o-Matic	X133
Moore-o-Matic	X150
Moore-o-Matic	Z133
Motorline	MC50BR
Motorline	MC50SC
Motorline	MC50SE
Mtec	UST 1K-KL
MultiCode	1099
MultiCode	3090
Nice	MC424
Nice	MC824H
Nice	POA1 (Control board)
Nice	POP
Nice	R01000
Nice	R01040
Nice	R01124
Nice	R01010
Nice	R0300
Nice	R0500
Nice	RUN 1500
Nice	RUN 1800
Nice	RUN 1800P
Nice	RUN 2500
Nice	RUN 2500P
Nice	Robus 1000
Nice	Robus 1000P
Nice	Robus 600
Nice	Robus 600P
Nice	SPIN
Nice	Soon
Nice	Spido 6000
Nice	Spin10KCE
Nice	Spin11KCE
NORMSTAHL	Magic 1000
NORMSTAHL	Magic 600
NORMSTAHL	ULTRA EXCELLENT
Novoferm	Novomatic 553
Novoferm	Novomatic 403
Novoferm	Safe 800 III
NRG Automation	Black Edition GDO
OEM	CTR32
Open Sesame Door Systems	Model 133
OVERHEAD DOOR	2026
OVERHEAD DOOR	4060L
OVERHEAD DOOR	456
OVERHEAD DOOR	556

Manufacturer	Model
OVERHEAD DOOR	656
OVERHEAD DOOR	65A
OVERHEAD DOOR	CD & CDB series
OVERHEAD DOOR	Destiny 1200
OVERHEAD DOOR	Destiny 1500
OVERHEAD DOOR	Legacy
OVERHEAD DOOR	Legacy 650
OVERHEAD DOOR	Legacy 800
OVERHEAD DOOR	Legacy 850
OVERHEAD DOOR	Model 1026
OVERHEAD DOOR	Model 1029
OVERHEAD DOOR	Model 2029
OVERHEAD DOOR	OCG550
OVERHEAD DOOR	OCG600
OVERHEAD DOOR	OCG750
OVERHEAD DOOR	OCG800
OVERHEAD DOOR	Phantom
OVERHEAD DOOR	ProMax PMX 75
OVERHEAD DOOR	ProMax PMX 85
OVERHEAD DOOR	Python
OVERHEAD DOOR	Python2
OVERHEAD DOOR	RSX
OVERHEAD DOOR	Signature 930
OVERHEAD DOOR	Signature 950
PADORS	PDS-101
PECCININ	CP 4000
PECCININ	CP2010
PECCININ	CP4030
PECCININ	CP5000
PECCININ	GATTER 3020
Platinum Access Systems	BLS840
POLARGOS	EASY WAY 201
Polaris	500
Polaris	502
Polaris	700
Polaris	702
Power Master	CSG
Power Master	RSG
POWERTECH	PL1000
POWERTECH	PL600
PRATEL	UNIK2E (Control Board)
PRATEL	UNIK2ESK (Control Board)
PROTECO	Kit MyDiamond
PROTECO	Q60A-R
PROTECO	Q80A - board-
PUJOL	Mini Marathon
Quantum	3212

Manufacturer	Model
Rademacher	Rolloport S1
Rademacher	Rolloport SX5
Ramset	RAM 100
Ramset	RAM 1000
Ramset	RAM 300
Ramset	RAM 5500
Ramset	Star 24
RAYNOR	FLITESTAR
RAYNOR	POWERHOIST STANDARD -PSJ- -PSH-
RDA	GTA 453
RIB	K400
Richards Wilcox	2265RWC
ROGER	BR20-500
ROGER	H70-103AC
Rollertec	V2
ROSSI	DZ3 SK
Ryobi	Ultra Quiet GD 200
RYTEC	System4
Saturn	E 600
SCHELLENBERG	DRIVE 600 N
SCHELLENBERG	DRIVE 800 N
SCHELLENBERG	Smart Drive 10
SCS	OpenGate3
SEA	GATE 2 DG
SEG	Pivus Plus
SEIP	EASY SM
SEIP	TM 60
SEIP	TS 100
SEIP	TS 75
Serai	Mercurio 300 F
Serai	Mercurio 500 F
Serai	Mercurio 800 F
SIMTECH	WJKMP201
SIMTECH	WJKMP202
SIMU	GM 800
SKY MASTER	330MX
SKY MASTER	F-350GX
SKY MASTER	F-350MX
Skylink Technology	ATMOS
Skylink Technology	EQ series
SOMFY	Axorn 50
SOMFY	Axorn 70
SOMFY	Axovia 220
SOMFY	ROLLIXO RTS
SOMMER	1042v001
SOMMER	1042v004
SOMMER	2060 evo+

Manufacturer	Model
SOMMER	2080 evo+
SOMMER	2110 evo+
SOMMER	Aperto
SOMMER	duo rapido 650
SOMMER	duo vision 500
SOMMER	duo vision 650
SOMMER	duo vision 800
SOMMER	Marathon 550 SL
SOMMER	GIGAControl A
SOMMER	S 9060
SOMMER	S 9080
SOMMER	S 9110
SOMMER	Sprint S 550N
SOMMER	Starglider 300
SOMMER	Synoris 550 - 800
SOMMER	TWIST 200 E
STANLEY	PT210
STANLEY	ST300
STANLEY	TT200
STEEL-LINE	BOL4
STEEL-LINE	FORZA
STEEL-LINE	SR60
STEEL-LINE	ST50EV0B
STEEL-LINE	STS0EVOC
SuperJack	EasyJack
SUPERLIFT	SDO-1C
SWS	Rollertec V2
SWS	SeceuroGlide
TAU	Control Board K120M
TAU	Control Board K125M
TAU	Control Board K580M
Telcoma	T101
Telcoma	T200
Telcoma	T201
TELECO	Mydoor Basic
Tormatic	GTA 601
Tormatic	GTA 602
Tousek	DYNAMIC T20S
Tousek	DYNAMIC T20S PRO
Tousek	DYNAMIC T25S
Tousek	DYNAMIC T25S PRO
Tousek	PRO 400

FAQ sulla risoluzione dei problemi

Non riesco ad accoppiare i dispositivi. Cosa posso fare?

- Assicuratevi di utilizzare una rete wifi a 2,4 GHz e di avere un segnale sufficientemente forte.
- Consentire all'applicazione tutti i permessi nelle impostazioni
- Assicuratevi di utilizzare l'ultima versione del sistema operativo mobile e l'ultima versione dell'applicazione.

Cosa devo fare se cambio rete o password Wi-Fi?

- Il modulo deve essere resettato e accoppiato nuovamente con l'applicazione.

Cosa succede se la rete Wi-Fi smette di funzionare?

- Se al modulo è collegato anche un interruttore fisico, il dispositivo può essere controllato senza problemi. Tuttavia, non sarà possibile controllare i moduli attraverso l'app finché la rete Wi-Fi non sarà attiva. Fanno eccezione i moduli ZigBee che possono essere controllati a distanza con altri dispositivi ZigBee, come l'EMOS H5011 Scenic Switch, anche dopo un'interruzione di Internet.